



A Donaldson Company

A WORLD LEADER IN FUME
EXTRACTION TECHNOLOGY

T 60

ELECTRONICS

Last Updated on 13.07.2018



Centralised tip extraction for lead and lead free solder applications

The T 60 high vacuum units are designed to extract and filter fumes and debris through small bore hoses and attachments. Ideally suited for soldering iron tip extraction, vac pens and any application requiring close proximity, micro extraction.

Due to high concentration of debris generated from up to 60 operators, this system has been designed to keep the unit compact, but still utilise a comprehensive filter system. With this in mind, the unit incorporates a facility for retaining a high concentration of particulate within the filter enclosure.

Technology



HEPA filter



Reverse Flow Air
technology



Advanced Carbon
Filter technology



ProTECT service
plan



SureCHECK
quality standard

Key features of the T60

Reverse flow
Standard

Low noise levels
Standard

Filter change indicator
Standard

Small footprint
Standard

Brushless motor
Standard

Tip extraction iron kit
Optional

Contact BOFA at <https://bofainternational.com/en/contact/>

<https://bofainternational.com/en/portal/datasheets/t60-2/>







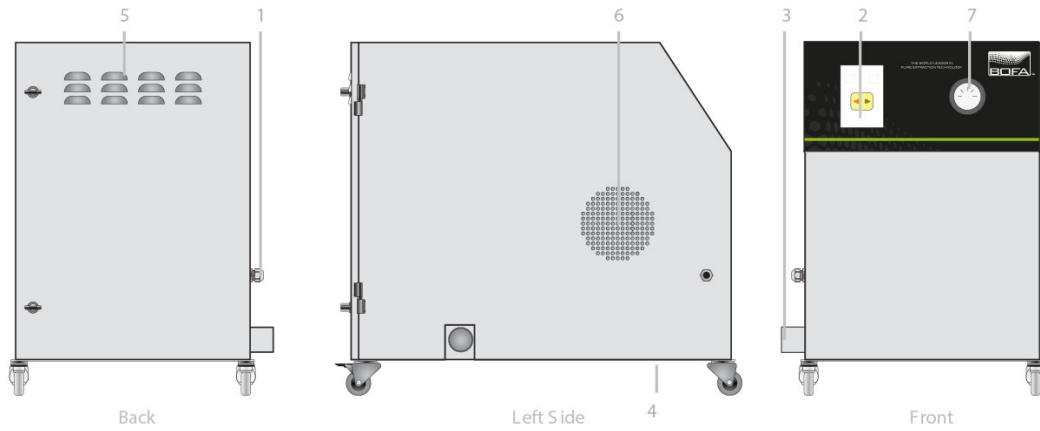

Technical specification

- 1. Power cable inlet
- 2. On / off switch
- 3. Hose inlet connection - 50mm
- 4. Exhaust outlet
- 5. Motor cooling outlet
- 6. Motor cooling inlet
- 7. Filter condition gauge



Airflow through filters

-  Chemical filter
-  HEPA filter
-  Pre filter
-  Clean air
-  Contaminated air
-  Particulate

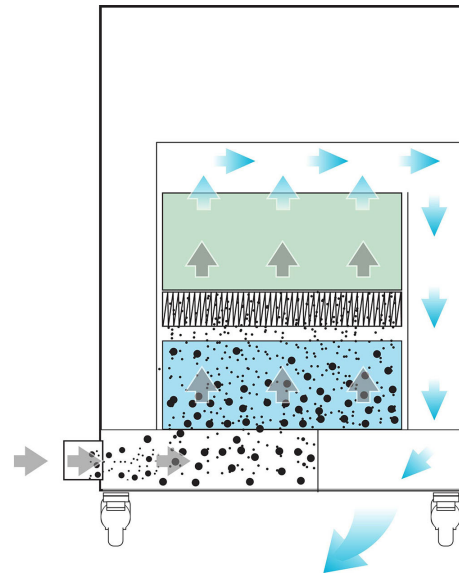

Technical data

	EU	US
Dimensions (HxWxD)	700 x 475 x 770 mm	27.6 x 18.7 x 30.3"
Cabinet construction	Powder coated mild steel	Powder coated mild steel
Recommended flow rate with filters fitted (per tip)	22 L/M	22 L/M
Electrical data	415v 3Ph 50Hz / 2.2 kw / 5.6A	415v 3Ph 50Hz / 2.2 kw / 5.6A
Noise level	< 70dBA (at typical operating speed)	< 70dBA (at typical operating speed)
Weight	80kg	176lbs
Pre filter efficiency	85% @ 0.8 microns	85% @ 0.8 microns
HEPA filter efficiency	99.997% @ 0.3 microns	99.997% @ 0.3 microns
Gas filter	Treated activated carbon	Treated activated carbon

Technical data

Approvals

CE

CE

Unit specifications

	230v	115v
Maximum number of Soldering Irons	60	72

Unit part numbers

Model	Voltage	Part no.
T 60 Powder coated	415v	E0542A0000

Filter part numbers

Model	Pre filter part no.	Combined filter part no.
T 60	A1030165	A1030164

Universal adjustable iron kit part numbers

Model	Part number
non ESD	A1090025
ESD	A1090026

Universal iron kit components

1. 6mm stainless steel tube
220mm long

2. 6mm stainless steel tube
110mm long

3. 5mm stainless steel tube
200mm long

4. 4 x E clips

5. 1 x clear plug

6. 2.5meters of 6.5mm x
4.5mm silicone hose

7. Small brass brush

8. Rubber tube to iron strap

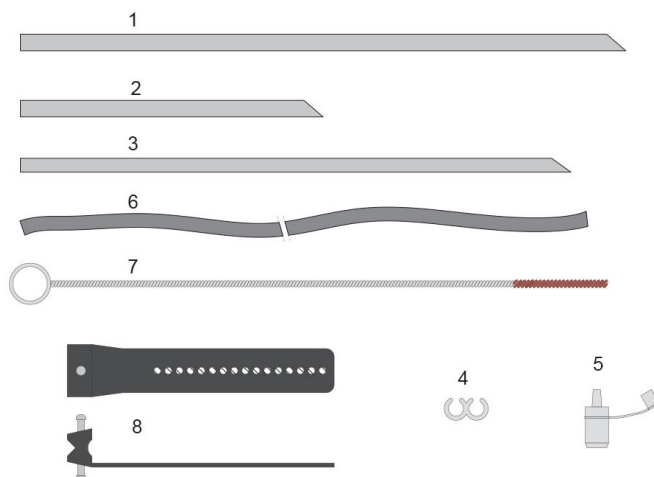

Other languages

T 60
[French](#)

Datasheet correct at time of publishing.

The carbon used in BOFA units is capable of removing a wide range of VOC's, however it is the responsibility of the user to ensure the carbon is suitable for their application. For specific applications, please contact us for details.

Think before you print! Please consider the environment before printing this document.

